

NSP3-50-275-N



Image for illustrative purposes only

NSP Surge Diverter

The NSP3-50-275-N provides all mode protection (L-N and N-PE) in accordance with AS3000 for three phase sub-boards remote from the MSB. It is rated for both 8/20 μ s and 10/350 μ s impulses making it suitable for use in moderately high exposure locations, for example in a sub-board fed by overhead conductors. It is also suitable for main switchboard protection in non-MEN (TT) distribution systems and can be used in MEN systems although the N-PE protection may be redundant due to the presence of the MEN link.

Pluggable Top

The Novaris NSP range features pluggable modules, colour coded orange for L-N and black for N-PE, where applicable.

Display and Alarm

The NSP range features a display window with green indicating operational and red indicating that replacement is necessary. A voltage free changeover contact allows for external alarm indication.

Overcurrent Protection

The NSP range requires external overcurrent protection as per AS3000. A 32A circuit breaker or fuse is recommended. Alternatively, the NSP could be paralleled with an existing power circuit. Since it draws negligible current under normal conditions it will not affect the circuit loading. A Novaris surge circuit breaker (SCB) may also be used.

Wiring

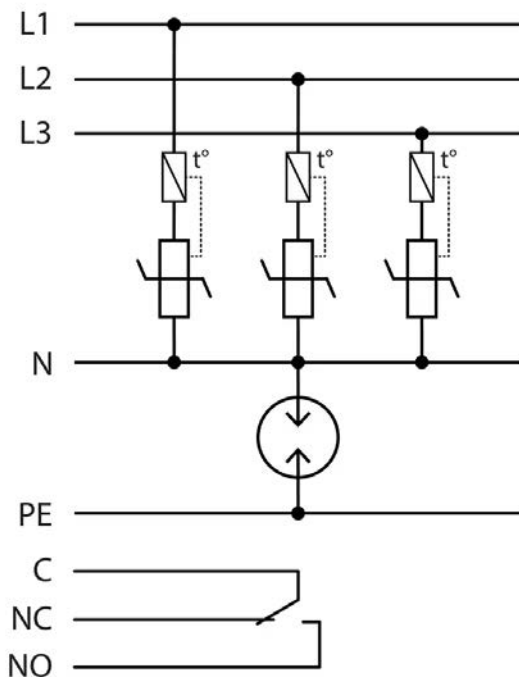



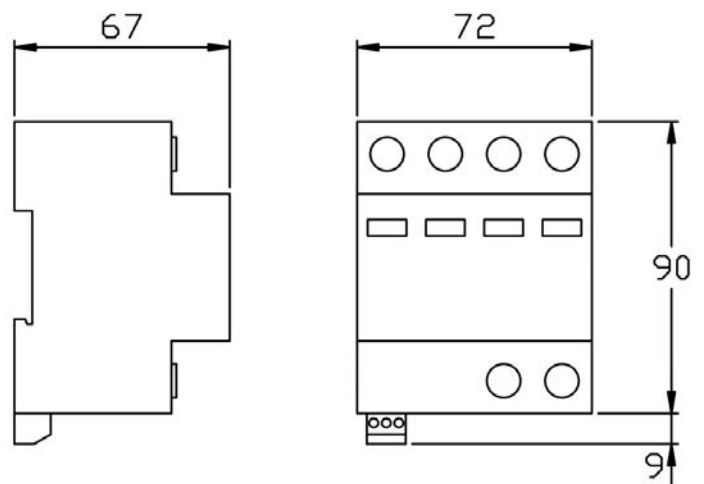

Dimensions



Product Datasheet

Electrical Specifications

Connection type		Shunt
Modes of protection		L-N, N-PE
Number of ports		1
Number of phases		3
Location		Indoor
Nominal voltage	U_0	230VAC
Short circuit withstand level	I_{SSCR}	25kA
Maximum backup fuse on CB		32A
Recommended SCB		SCB1-3-80

Electrical (L-N) Specifications

Maximum continuous voltage AC	U_C	275VAC
Maximum discharge current (8/20 μ s)	I_{max}	50kA
Nominal discharge current (8/20 μ s)	I_n	20kA
Lightning impulse current (10/350 μ s)	I_{imp}	7.5kA
Voltage protection level (In)	U_p	<1200V
Response time	t_A	<25ns











Electrical (N-PE) Specifications

Maximum continuous voltage	U_C	255VAC
Maximum discharge current (8/20 μ s)	I_{max}	50kA
Nominal discharge current (8/20 μ s)	I_n	20kA
Lightning impulse current (10/350 μ s)	I_{imp}	12.5kA
Voltage protection level (1kV/ μ s)	U_p	<1500V
Response time	t_A	<100ns
Follow current interrupt rating	I_{fi}	100A

Indication Specifications

Display		Thermal failure green normal red failure
---------	---	--

Mechanical Specifications

Minimum operating temperature		-40°C
Maximum operating temperature		80°C
Minimum operating humidity		5%
Maximum operating humidity		95%
Mounting method		TS35 DIN Rail
Environmental rating		IP20
Terminal capacity - power		6mm ²
Length		99mm
Width		72mm
Height		67mm

Other Specifications

Product Code		NSP3-50-275-N
--------------	---	---------------

Shipping Specifications

Weight		450g
Customs tariff		85363000, 85363010

Standard Specifications

IEC 61643-11	SPD connected to low-voltage power systems - Type 1, Type 2
AS 1768	LPZ0B/1, LPZ1/2

Generated Wed Nov 08 2023